



INSTRUCTION MANUAL

1200 MHz
FM TRANSCEIVER

IC-1201A
IC-1201E



CAUTIONS

Before using the transceiver, read all the instructions carefully and completely.

SAVE THIS INSTRUCTION MANUAL — This instruction manual contains important safety and operating instructions for the IC-1201A/E.

NEVER connect the transceiver to an AC outlet. This will ruin the transceiver.

NEVER connect more than 16 V DC power to the transceiver. Check the source voltage before connecting the power cable.

NEVER allow children to touch the transceiver during operation.

NEVER expose the transceiver to rain, snow or any liquids.

AVOID using or storing the transceiver in places with temperatures below -10°C ($+14^{\circ}\text{F}$) or over $+60^{\circ}\text{C}$ ($+140^{\circ}\text{F}$).

DO NOT place the transceiver in excessively humid environments.

AVOID placing the transceiver in direct sunlight, such as on the dashboard.

AVOID placing in excessively dusty environments.

BE CAREFUL! The heatsink may become hot when operating the transceiver for long periods.

TABLE OF CONTENTS

CAUTIONS	i	6 RELATED FUNCTIONS	16
TABLE OF CONTENTS	ii	6-1 AFC, RIT AND VXO OPERATIONS	16
FOREWORD	iii	6-2 MEMORY OPERATIONS	18
UNPACKING	iii	6-3 SCAN FUNCTIONS	20
1 FEATURES	1	6-4 PRIORITY WATCH	24
2 PANEL DESCRIPTION	2	6-5 CALL CHANNEL MODE	26
2-1 FRONT PANEL	2	6-6 DIMMER CONTROL	27
2-2 FUNCTION DISPLAY ..	4	6-7 BEEP ON/OFF	27
2-3 REAR PANEL	5	6-8 LOCK FUNCTION	27
2-4 MICROPHONE	5	7 POCKET BEEP AND TONE	
3 INSTALLATION	6	SQUELCH	28
4 MODE CONSTRUCTION	9	7-1 UT-40 INSTALLATION ..	28
5 BASIC OPERATIONS	11	7-2 POCKET BEEP FUNCTION	29
5-1 FREQUENCY SETTING	11	7-3 TONE SQUELCH FUNCTION	29
5-2 RECEIVING	12	8 MAINTENANCE	30
5-3 TRANSMITTING	12	8-1 TROUBLESHOOTING ..	30
5-4 REPEATER OPERATION	14	8-2 CPU RESETTING	31
		8-3 MISCELLANEOUS MAINTENANCE	32
		9 INSIDE VIEWS	33
		10 SPECIFICATIONS	34
		11 OPTIONS	35
		SCHMATIC/BLOCK DIAGRAM	SEPARATE

FOREWORD

Thank you for purchasing the **IC-1201A/E 1200 MHz FM TRANSCEIVER** from Icom.

Please read this instruction manual thoroughly before operating your new **IC-1201A/E**. For further information, please feel free to contact your nearest Icom Dealer or Service Center.

UNPACKING

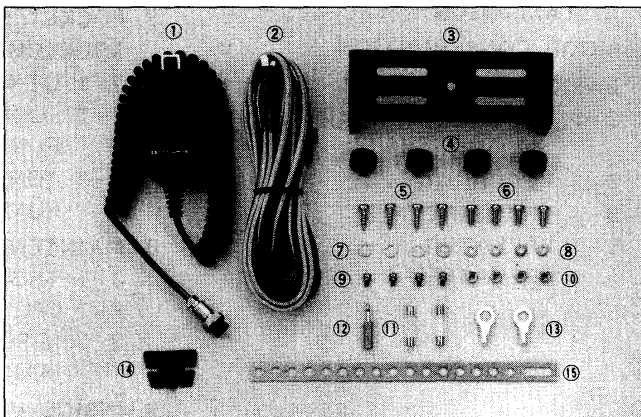

Accessories included	Qty.
① Microphone*	1
② DC power cable	1
③ Mobile mounting bracket	1
④ Mounting bracket knobs	4
⑤ Self-tapping screws (AO 5 x 16)	4
⑥ Screws (M5 x 12)	4
⑦ Flat washers (M5)	4
⑧ Flat washers (M4)	4
⑨ Set screws (A) 4 x 8	4
⑩ Nuts (M5)	4
⑪ Fuses (10 A)	2
⑫ External speaker plug	1
⑬ Cable lugs	2
⑭ Microphone hanger	1
⑮ Support bracket	1

* HM-12 for IC-1201A (U.S.A. version)

HM-15 for IC-1201E (Europe version)

●AFC FUNCTION

Icom's advanced AFC* system automatically and immediately tunes the receive frequency or both transmit and receive frequencies to the frequency of the transmitting station when transmitting station is off frequency.

* Automatic Frequency Control

●HIGH SENSITIVITY

A GaAs FET MGF1502 is used for the RF front end circuit. The FET ensures low noise figure characteristics and superior sensitivity at less than 0.22 μ V for 12 dB SINAD.

●20 MEMORY CHANNELS

The IC-1201A/E contains 20 fully programmable channels and 1 call channel. Each channel can store all information required to work a repeater.

●SCAN FUNCTIONS

The IC-1201A/E is equipped with 2 scan functions: programmed scan and memory scan. A memory skip function is also included. In addition, priority watch waits for a call from a station while you're in contact with another station.

●STABLE OUTPUT POWER

The IC-1201A/E utilizes a newly designed Icom power module (SC-1066). This module steadily transmits 10 W of clean powerful output.

●POCKET BEEP FUNCTION

When the optional UT-40 TONE SQUELCH UNIT is installed, a 30 sec. alarm is emitted when a subaudible tone identical to your pre-programmed tone is received. This is especially convenient for busy schedules, etc.

●COMPACT BODY

Compact at just 140(W) x 40(H) x 200(D) mm [5.5(W) x 1.6(H) x 7.9(D) in]*, the IC-1201A/E will fit anywhere in your vehicle, making it the ideal traveller.

* Projections not included.

2-1 FRONT PANEL

TRANSMIT INDICATOR [TX]

Lights while transmitting. (p. 13)

RECEIVE INDICATOR [RX]

Lights when the squelch opens. (p. 12)

CALL CHANNEL SWITCH [CALL]

Selects a call channel. (p. 26)

VFO/MEMORY SWITCH [VFO/M]

Selects VFO or MEMORY mode. (pgs. 11, 18)

TUNING CONTROL

- Changes the operating frequency. (p. 11)
- Changes the memory channel. (p. 18)
- Changes contents of SET mode displays. (p. 10)

MEMORY WRITE SWITCH [MW]

- Writes a memory channel. (p. 19)
- Transfers the contents of a memory channel to the VFO. (p. 19)
- Programs a call channel. (p. 26)

LOCK SWITCH [LOCK]

Deactivates the TUNING CONTROL and some switches. (p. 27)

SET MODE SWITCH [SET]

- Selects SET mode and advances SET mode displays. (p. 10)
- Programs a memory channel to be skipped in MEMORY mode. (p. 23)

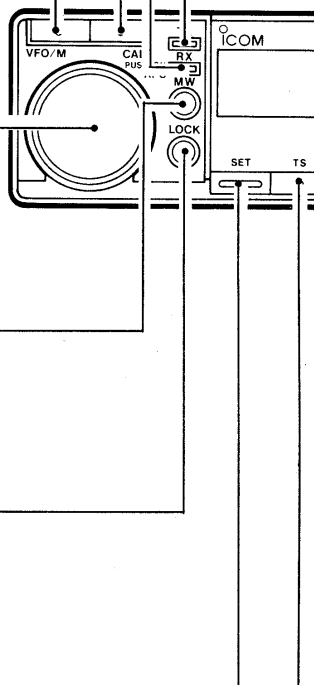

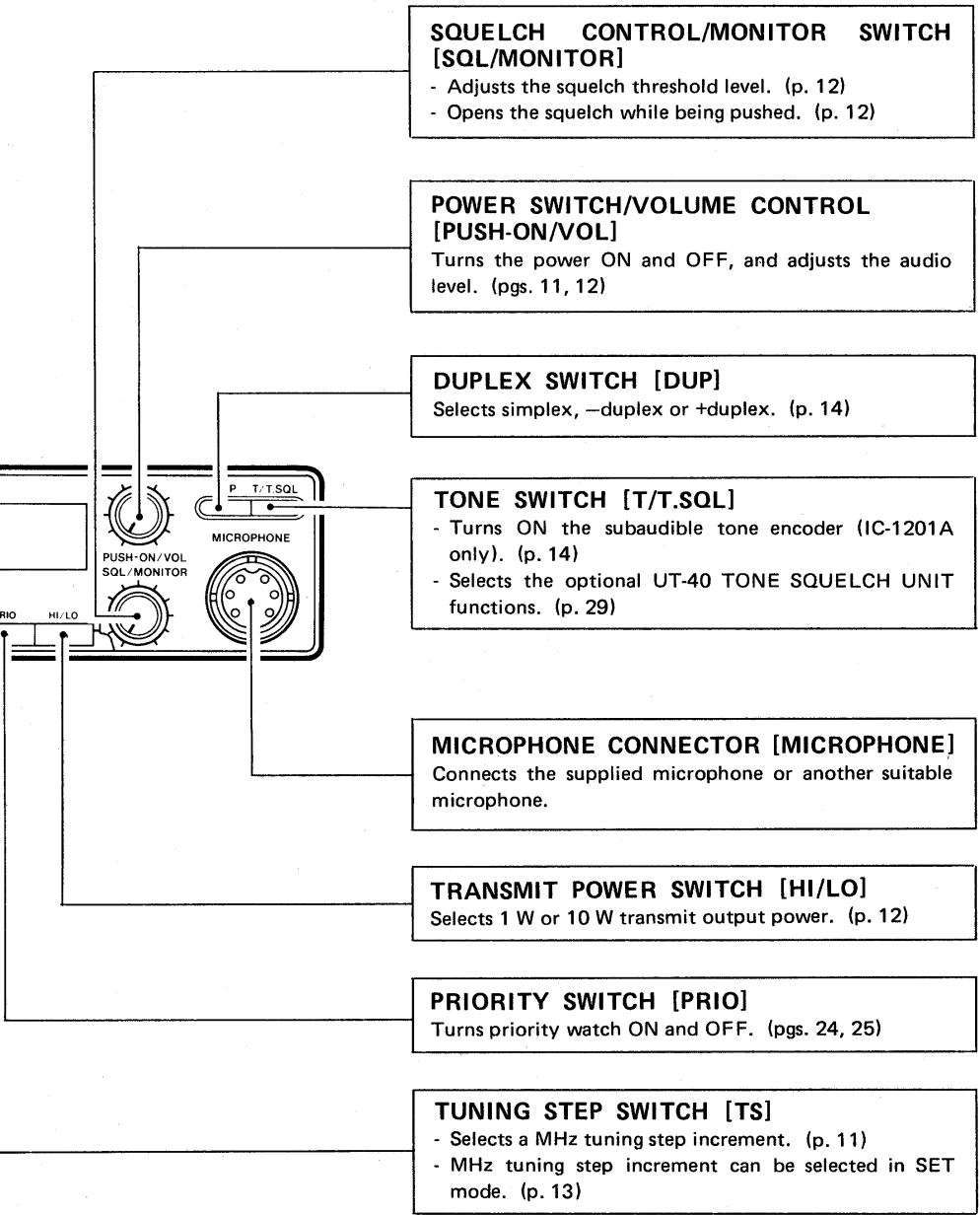

SQUELCH CONTROL/MONITOR SWITCH [SQL/MONITOR]

- Adjusts the squelch threshold level. (p. 12)
- Opens the squelch while being pushed. (p. 12)

POWER SWITCH/VOLUME CONTROL [PUSH-ON/VOL]

Turns the power ON and OFF, and adjusts the audio level. (pgs. 11, 12)

DUPLEX SWITCH [DUP]

Selects simplex, -duplex or +duplex. (p. 14)

TONE SWITCH [T/T.SQL]

- Turns ON the subaudible tone encoder (IC-1201A only). (p. 14)
- Selects the optional UT-40 TONE SQUELCH UNIT functions. (p. 29)

MICROPHONE CONNECTOR [MICROPHONE]

Connects the supplied microphone or another suitable microphone.

TRANSMIT POWER SWITCH [HI/LO]

Selects 1 W or 10 W transmit output power. (p. 12)

PRIORITY SWITCH [PRIO]

Turns priority watch ON and OFF. (pgs. 24, 25)

TUNING STEP SWITCH [TS]

- Selects a MHz tuning step increment. (p. 11)
- MHz tuning step increment can be selected in SET mode. (p. 13)

2 PANEL DESCRIPTION

2-2 FUNCTION DISPLAY

PRIORITY INDICATOR

Appears during priority watch. (p. 24)

CENTER INDICATORS

- Indicate the direction a signal from the transmitting station is off frequency when the AFC function is activated. (p. 16)
- Indicate a fine tuning direction when the RIT or VXO function is activated. (p. 17)

DUPLEX INDICATORS

- "DUP—" appears when —duplex is selected. (p. 14)
- "DUP" appears when +duplex is selected. (p. 14)

TONE INDICATOR

- "T" appears when the subaudible tone encoder is turned ON (IC-1201A only). (p. 14)
- "SQL" appears when the optional UT-40 pocket beep function is activated. (p. 29)
- "T SQL" appears when the optional UT-40 tone squelch function is activated. (p. 29)

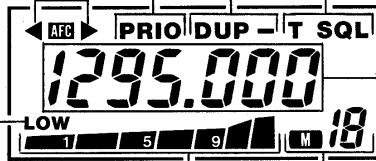

LOW POWER INDICATOR

Appears when LOW output power is selected with the [HI/LO] switch. (p. 12)

FREQUENCY READOUT

Displays the operating frequency except in SET mode.

S/R/F INDICATOR

- Shows signal strength when receiving. (p. 12)
- Shows relative output power selection when transmitting. (p. 13)

MEMORY INDICATOR

Appears when MEMORY mode is selected with the [VFO/M] switch. (p. 18)

MEMORY CHANNEL READOUT

- Displays the memory channel number. (p. 18)
- Displays "C" when the CALL CHANNEL mode is selected with the [CALL] switch. (p. 26)
- Displays "L" when the lock function is activated. (p. 27)

2-3 REAR PANEL

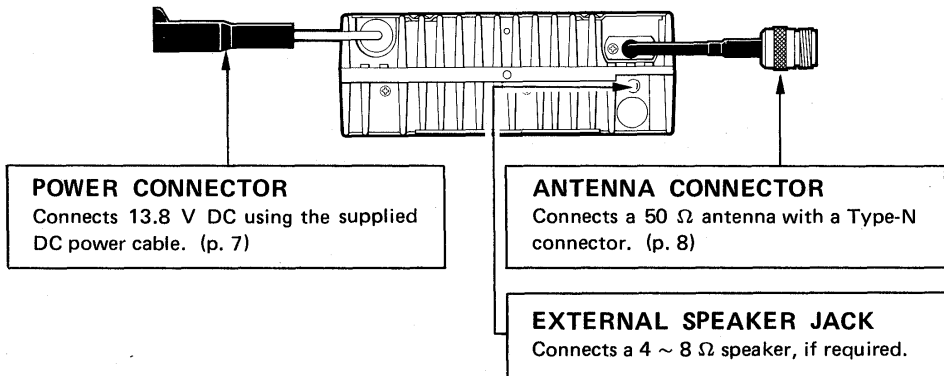

2-4 MICROPHONE

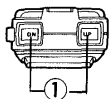

HM-12

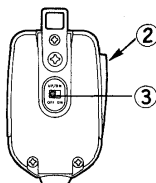

HM-15

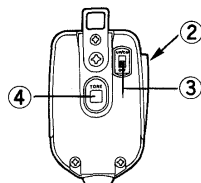

① FREQUENCY UP/DOWN SWITCHES [UP], [DN]

- Push either switch to change the operating frequency. (p. 11)
- Push either switch to change a memory channel. (p. 18)
- Push and hold either switch to start scanning. (pgs. 20, 22)

② PTT SWITCH

Push and hold to transmit. (p. 13)

③ UP/DOWN ON/OFF SWITCH [UP/DN ON OFF]

Deactivates the [UP] and [DN] switch.

④ TONE CALL SWITCH [TONE] (HM-15 only)

Push and hold to transmit a 1750 Hz tone call signal to access a repeater. (p. 14)

• MIC CONNECTOR (Front panel view)

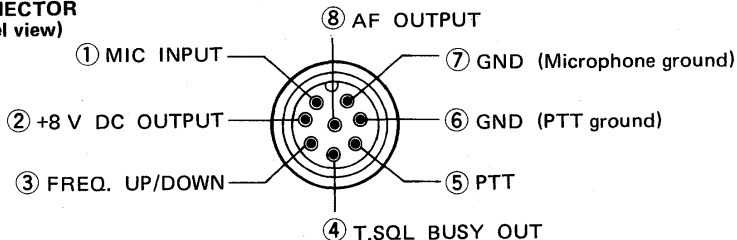

3

INSTALLATION

(1) LOCATION

Select a location for the transceiver that does not interfere with driving in any way. We recommend the location shown in the figure below.

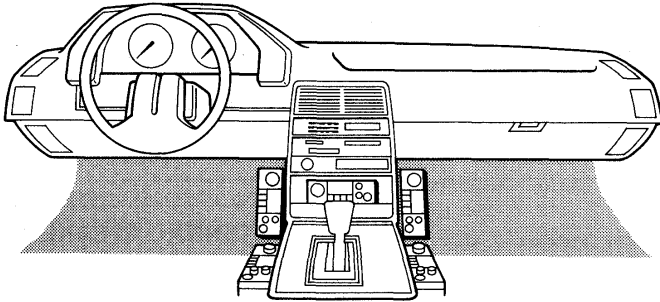

CAUTION

AVOID placing the transceiver in direct sunlight.
NEVER place the transceiver where normal operation of the vehicle may be hindered or where it could cause bodily injury.
DO NOT place the transceiver where hot or cold air blows directly on it.

(2) MOUNTING

After mounting the transceiver, be sure all screws have been tightened.

• MOUNTING THE TRANSCEIVER

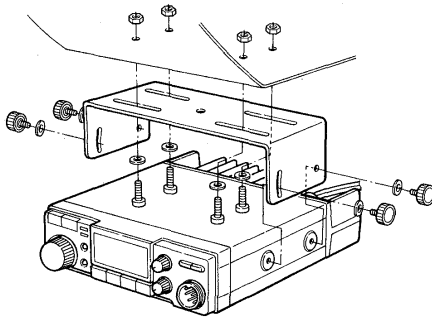

1) Drill holes where the mounting bracket is to be installed.

• Hole size:

approx. 5.5 ~ 6 mm for nuts.

approx. 2 ~ 3 mm for self-tapping screws.

2) Insert the supplied screws, nuts and washers through the mounting bracket and tighten.

3) If the mounting location is not flat, use the supplied mounting support bracket.

4) Adjust the angle for the clearest view of the FUNCTION DISPLAY.

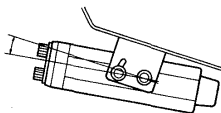

Adjust installation angle for good visibility.

(1 inch = 25.4 mm)

(3) BATTERY CONNECTION

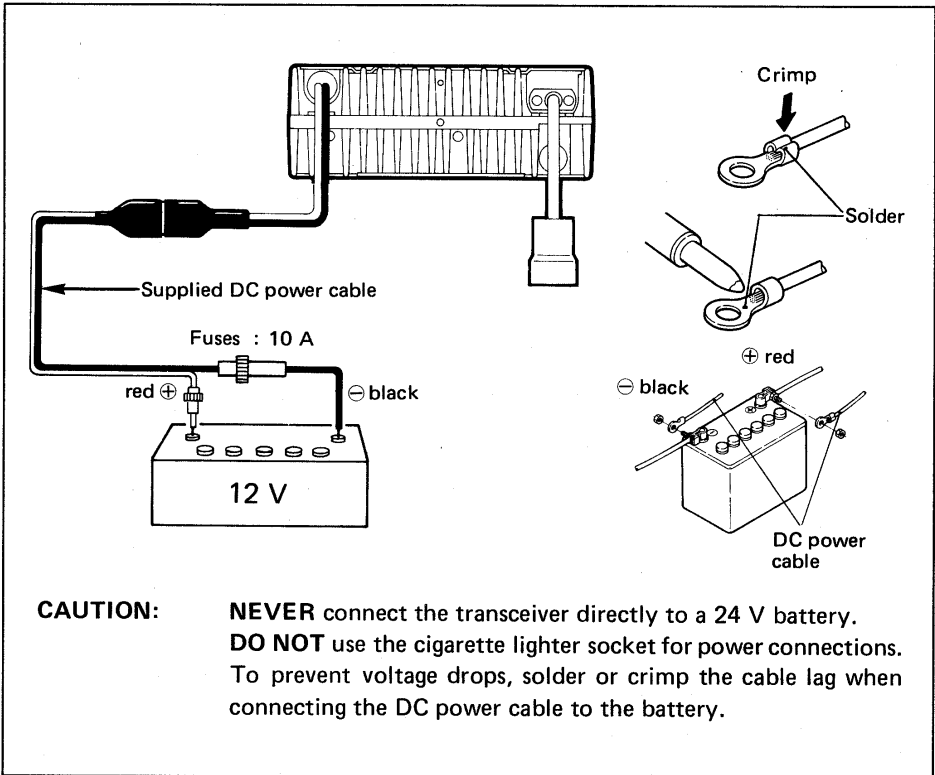

(4) EXTERNAL POWER SUPPLY

Use a 13.8 V DC power source with more than 6 A capability. The optional PS-45 AC POWER SUPPLY is suitable for base station operation.

When using the transceiver as a base station, make sure a ground terminal of the power supply is grounded. Use the heaviest gauge wire or strap available and make the connection as short as possible.

3 INSTALLATION

(5) ANTENNA LOCATION

To obtain maximum performance from the transceiver, select a high-quality antenna and a good location.

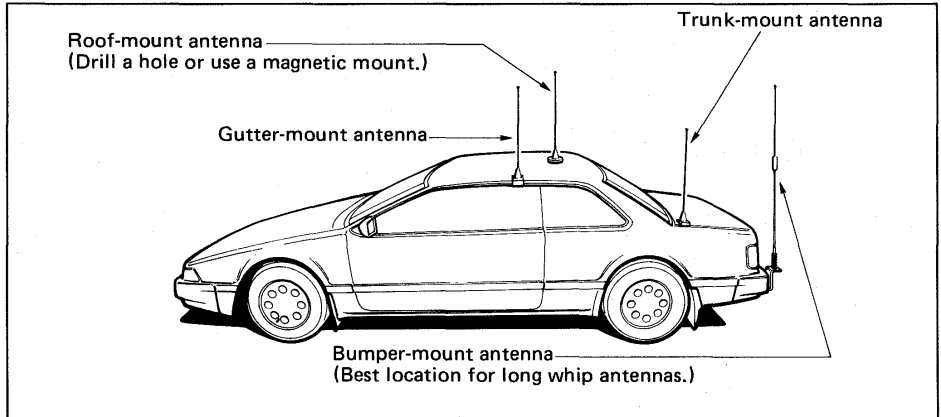

(6) ANTENNA CONNECTOR

A Type-N antenna connector is used for the transceiver.

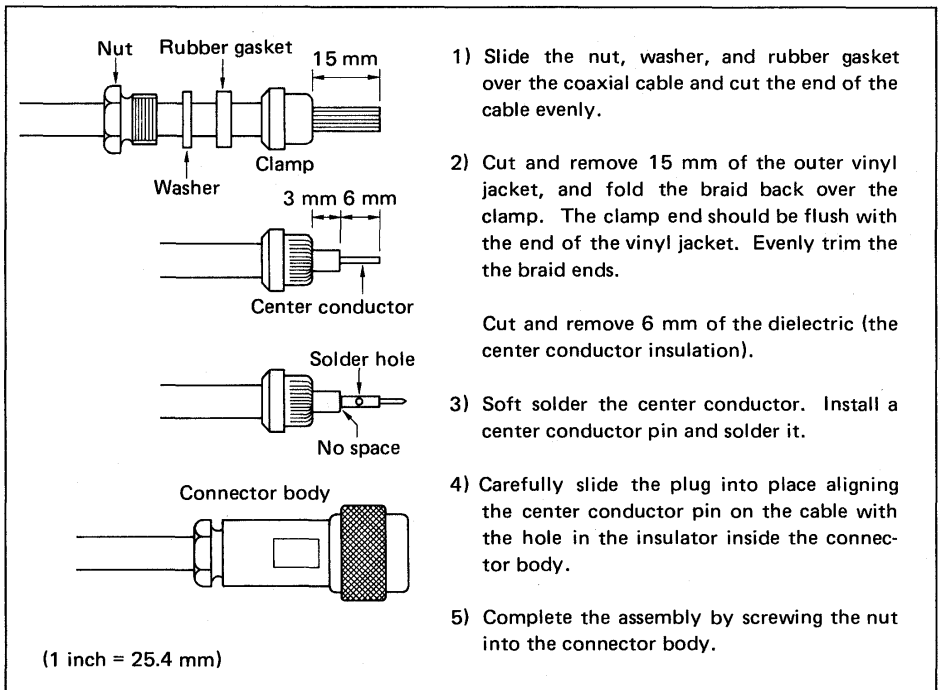

The IC-1201A/E has 4 different modes for versatile multi-function operations.

(1) VFO MODE



(2) MEMORY MODE

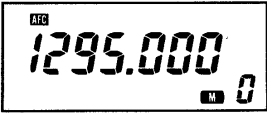

(3) CALL CHANNEL MODE

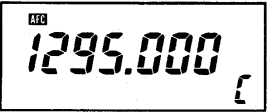

(4) SET MODE



This mode is used for normal operations over the entire band.

This mode is used for operating the transceiver using memory channel contents. You can use 20 memory channels for programming (i.e., repeater frequencies, your ground frequency, etc.).

This mode provides 1 call channel operation separate from the memory channel. You can program the most often used frequency into this channel.

Use SET mode to program data. (p. 10)

Push the [SET] switch to select SET mode in the VFO mode. The display you last used appears.

MODE CONSTRUCTION CHART

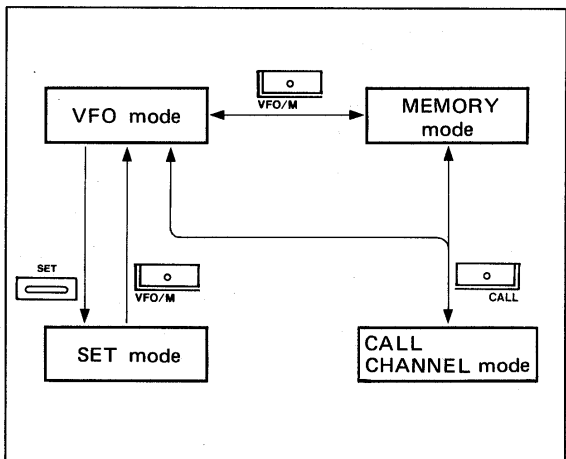

4 MODE CONSTRUCTION

■ SET MODE CONSTRUCTION CHART

Push the [SET] switch while in VFO mode to select SET mode. The previously set position appears.

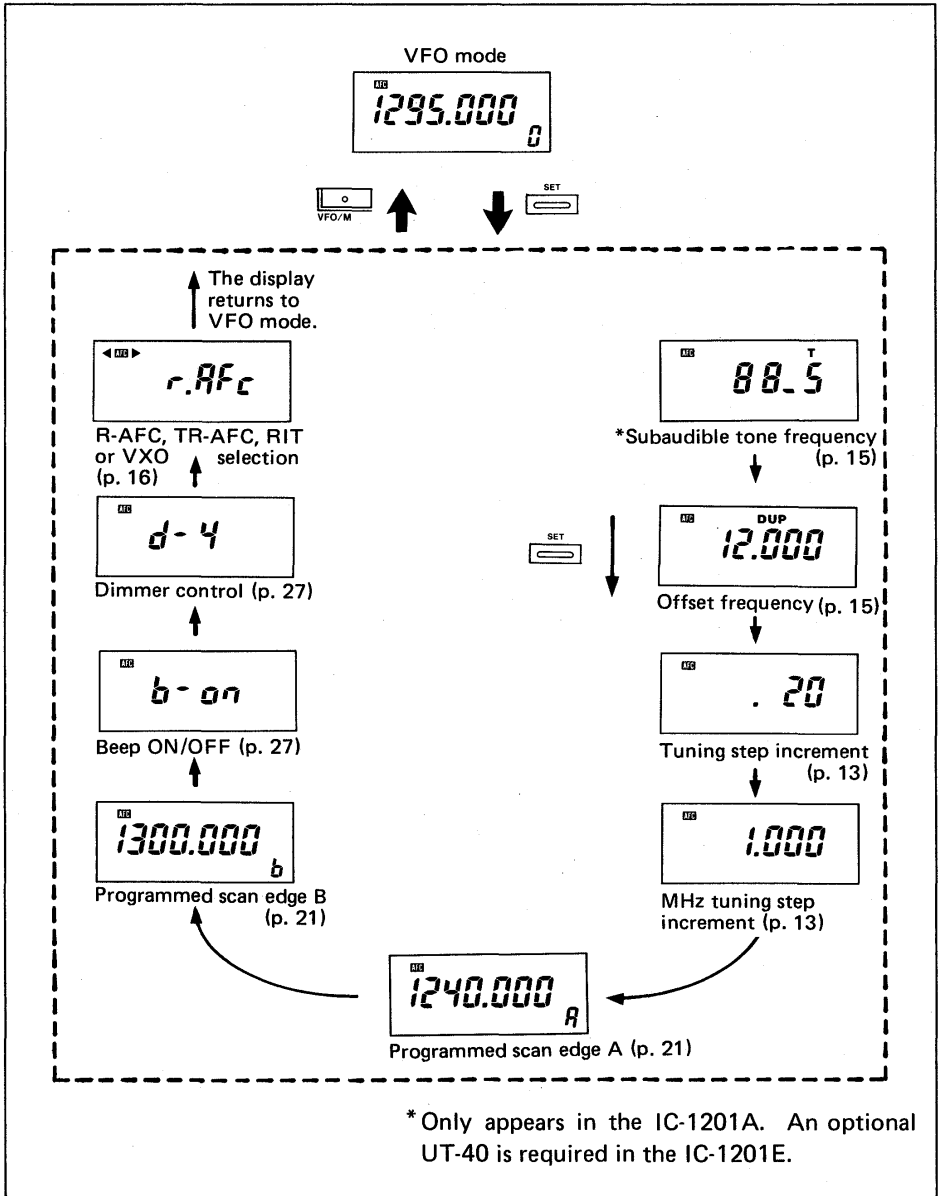

5-1 FREQUENCY SETTING

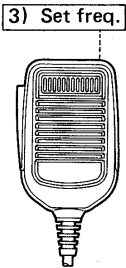
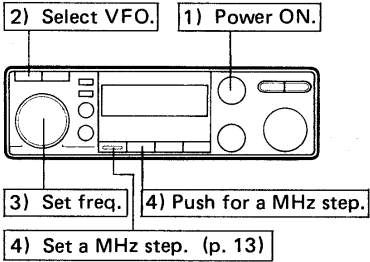

The frequency can be set with the TUNING CONTROL or the [UP] or [DN] switch on the microphone.

- 1) Push the [PUSH-ON/VOL] control to turn ON power.
- 2) When "M" or "C" appears on the FUNCTION DISPLAY, push the [VFO/M] switch to select VFO mode.
- 3) Rotate the TUNING CONTROL or push the [UP] or [DN] switch on the microphone to change the operating frequency.
 - Select a tuning step increment in SET mode. (p. 13)

NOTE: When the decimal point disappears the TUNING CONTROL does not change the operating frequency since the RIT or VXO function is activated. In this case, push the TUNING CONTROL to turn OFF the function. (p. 17)

- 4) Push the [TS] switch to select a MHz tuning step increment.
 - The TUNING CONTROL changes the frequency in a MHz step.
 - The [UP] or [DN] switch on the microphone does not change the frequency in a MHz step.
 - Push the [TS] switch again to return to the previous tuning step.

5 BASIC OPERATIONS

5-2 RECEIVING

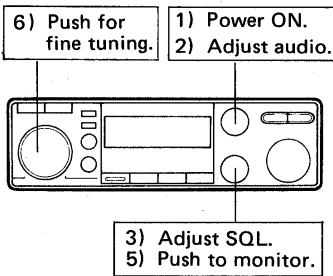

- 1) Push the [PUSH-ON/VOL] control to turn power ON and rotate the [SQL/MONITOR] control maximum counterclockwise.
 - The [RX] indicator lights.
- 2) Rotate the [PUSH-ON/VOL] control to the desired audio level.
- 3) Rotate the [SQL/MONITOR] control to the squelch threshold point.
- 4) Set the desired frequency with the TUNING CONTROL or the [UP] or [DN] switch on the microphone.
- 5) To monitor the operating frequency momentarily, push the [SQL/MONITOR] control.
 - The squelch opens while the [SQL/MONITOR] control is pushed.
- 6) Use the R-AFC, TR-AFC, RIT or VXO function, if required. (p. 16)

5-3 TRANSMITTING

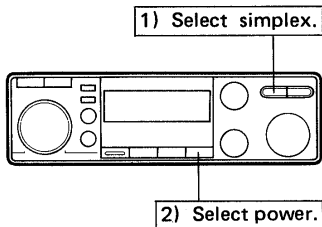

CAUTION: Transmitting without an antenna may damage the transceiver.

NOTE: To prevent interference, listen on the frequency before transmitting.

- 1) When "DUP—" or "DUP" appears on the FUNCTION DISPLAY, push the [DUP] switch until it disappears to select a simplex mode.
 - Select duplex mode for repeater operation. (p. 14)
- 2) Push the [HI/LO] switch to select output power.
 - HIGH : 10 W LOW : 1 W
 - "LOW" appears only when LOW power is selected.

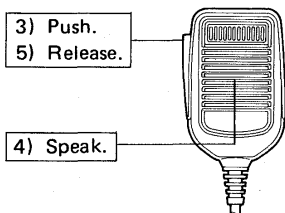

- 3) Push and hold the [PTT] switch on the microphone.
 - The [TX] indicator lights and the S/R F INDICATOR shows relative output power selection.
- 4) Speak into the microphone using your normal voice level.
 - Do not hold the microphone too closely to your mouth or speak too loudly. This may distort the signal.
- 5) Release the [PTT] switch to return to receiving.

USING SET MODE

■ SETTING TUNING STEP INCREMENTS

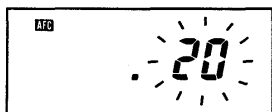

- 1) Select VFO mode. (p. 11)
- 2) Push the [SET] switch until a tuning step increment flashes on the FUNCTION DISPLAY as shown at left.
 - IC-1201A : 10 or 20 kHz
 - IC-1201E : 12.5 or 25 kHz
- 3) Rotate the TUNING CONTROL for the desired tuning step increment.
- 4) Push the [SET] switch again.
- 5) Rotate the TUNING CONTROL to select MHz tuning step increments as shown below:

FUNCTION DISPLAY	MHz TUNING STEP INCREMENT
1.000	1 MHz
5.000	5 MHz
10.000	10 MHz

- 6) Push the [VFO/M] switch to set increments and to return to VFO mode.

5 BASIC OPERATION

5-4 REPEATER OPERATION

When you want to contact a station through a repeater, set the transceiver to duplex. To access a repeater which requires a tone, see below.

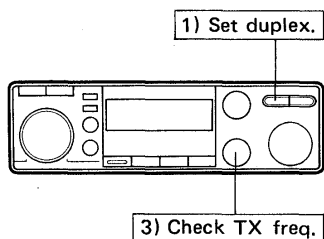

- 1) Push the [DUP] switch once to set -duplex or push again to set +duplex.
 - "DUP-" or "DUP" appears on the FUNCTION DISPLAY.

"DUP-" : Transmit freq. =
Receive freq. - Offset freq.
"DUP" : Transmit freq. =
Receive freq. + Offset freq.

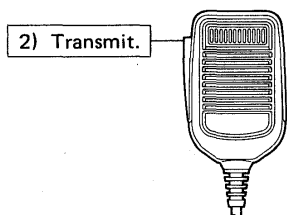

- 2) Push the [PTT] switch to transmit on the repeater input frequency.
- 3) To check transmit frequency (repeater input frequency), push the [SQL/MONITOR] control.
 - The squelch opens.
 - This allows checking of the signal strength of your contacted station directly without going through a repeater.

• SUBAUDIBLE TONE (IC-1201A only)

Push the [T/T.SQL] switch to turn the subaudible tone encoder ON and OFF.



"T" appears on the FUNCTION DISPLAY.

• 1750 Hz TONE CALL (IC-1201E only)

Push and hold the [TONE] switch on the microphone for about 1 ~ 3 sec. to transmit 1750 Hz tone call signals.

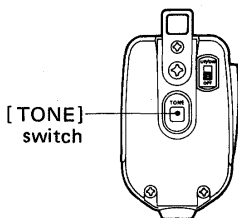

USING SET MODE

■ **SETTING A
SUBAUDIBLE TONE
FREQUENCY**

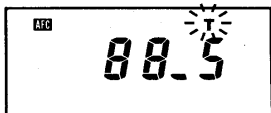

The display shows that the subaudible tone frequency is set at 88.5 Hz.

Select one of 38 subaudible tone frequencies for some repeater operations. When the optional UT-40 is installed, select one of 37 subaudible tone frequencies.

- 1) Select VFO mode. (p. 11)
- 2) Push the [SET] switch until "T" flashes on the FUNCTION DISPLAY as shown at left.
- 3) Rotate the TUNING CONTROL to select the desired subaudible tone frequency.
- 4) Push the [VFO/M] switch to return to VFO mode.

USING SET MODE

■ **SETTING AN OFFSET
FREQUENCY**

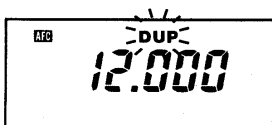

The display shows that the offset frequency is set at 12 MHz.

When duplex operation has been selected, the transceiver transmits on a frequency equal to the receive frequency plus or minus the offset frequency.

- 1) Select VFO mode. (p. 11)
- 2) Push the [SET] switch until "DUP" flashes on the FUNCTION DISPLAY as shown at left.
- 3) Rotate the TUNING CONTROL to select the desired offset frequency.
 - Use the [TS] switch to select a MHz tuning step increment. (p. 13)
- 4) Push the [VFO/M] switch to set the frequency and to return to VFO mode.

6

RELATED FUNCTIONS

6-1 AFC, RIT AND VXO OPERATIONS

(1) PRESETTING

When the transmitting station is off frequency, select one of four functions in SET mode as described below.

■ R-AFC FUNCTION

Automatically fine tunes receive frequency to the frequency of the transmitting station. Use this function when the transmitting station uses the AFC function.

■ TR-AFC FUNCTION

Automatically fine tunes both transmit and receive frequencies to the frequency of the transmitting station. Use this function when the transmitting station does not use the AFC function.

■ RIT FUNCTION

Manually fine tunes receive frequency.

■ VXO FUNCTION

Manually fine tunes both transmit and receive frequencies.

USING SET MODE

■ SELECTING THE R-AFC, TR-AFC, RIT OR VXO OPERATION

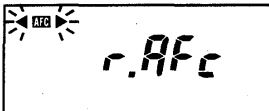

The display shows that R-AFC is selected.

- 1) Select VFO mode. (p. 11)
- 2) Push the [SET] switch to select the desired operation until "r.AFc", "tr.AFc", "rit" or "UHo" appears as shown at left.
- 3) Rotate the TUNING CONTROL to select the desired function described below:

FUNCTION	DISPLAY	FINE TUNING	
		TRANSMIT FREQUENCY	RECEIVE FREQUENCY
R-AFC	r.AFc	—	Auto
TR-AFC	tr.AFc	Auto	Auto
RIT	rit	—	Manual
VXO	UHo	Manual	Manual

- 4) Push the [VFO/M] switch to set the operation and to return to VFO mode.

(2) AFC OPERATION

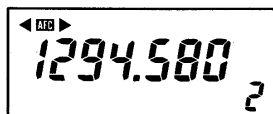
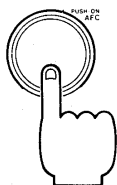

- 1) Select R-AFC or TR-AFC using SET mode. (p. 16)
- 2) Push the TUNING CONTROL to activate the AFC function.
 - AFC automatically and immediately fine tunes receive frequency or both receive and transmit frequencies to the frequency of the transmitting station.
 - “◀” or “▶” flashes while AFC tunes or when the off frequency is within approx. $\pm 5.5 \sim 7.0$ kHz.
 - The decimal point does not disappear.
- 3) Push the TUNING CONTROL again to cancel the function.

(3) RIT OR VXO OPERATION

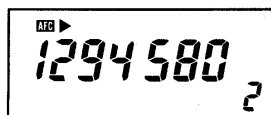
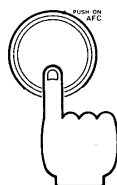

- 1) Select the RIT or VXO function using SET mode.
- 2) Push the TUNING CONTROL to activate the RIT or VXO function.
 - The decimal point disappears.
 - “◀” and/or “▶” appear.
 - “◀” or “▶” shows the fine tuning direction.
 - RIT or VXO operates in a range of ± 5.5 kHz.
 - “◀” or “▶” flashes when RIT or VXO exceeds operation range of ± 5.5 kHz.
- 3) Rotate the TUNING CONTROL for fine tuning.
- 4) Push the TUNING CONTROL again to cancel the function.

6 RELATED FUNCTIONS

6-2 MEMORY OPERATIONS

The transceiver has 20 memory channels. Each memory channel independently stores an operating frequency, offset frequency, subaudible tone frequency (the IC-1201A or IC-1201E with the optional UT-40), and memory skip function.

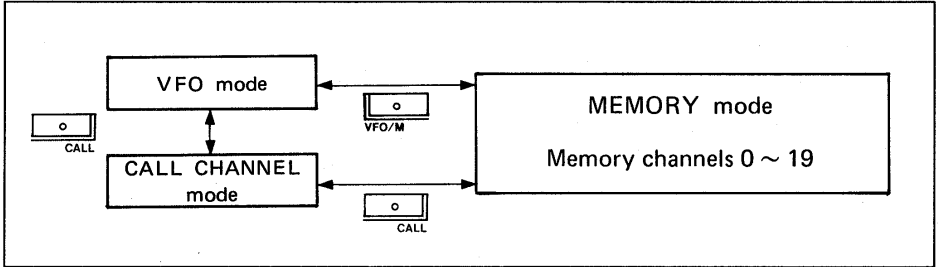

(1) MEMORY READING

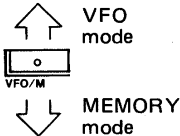
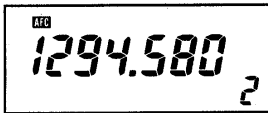

- 1) Push the [VFO/M] switch to select MEMORY mode.
 - "M" appears on the FUNCTION DISPLAY.
- 2) Rotate the TUNING CONTROL to select the desired memory channel.
 - The [UP] or [DN] switch on the microphone also changes the memory channel.
- 3) Push the [VFO/M] switch again to return to VFO mode.

(2) MEMORY WRITING

In VFO mode

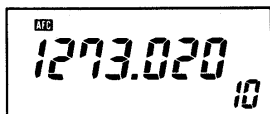

Push and hold.

- 1) Push the [VFO/M] switch to select MEMORY mode.
- 2) Rotate the TUNING CONTROL to select the desired memory channel.
- 3) Push the [VFO/M] switch to select VFO mode.
 - "M" disappears from the FUNCTION DISPLAY.
- 4) Select the operating frequency. (p. 11)
 - Repeater or other information contents can be programmed. (pgs. 14, 29)
- 5) Push and hold the [MW] switch until three beeps are emitted from the speaker.
 - The information is now programmed.

(3) MEMORY TRANSFERRING

In MEMORY mode

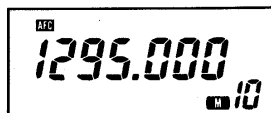

Push and hold.

Copy and transfer the displayed memory contents into VFO. This function is useful for searching for signals around the memory channel frequency.

The memory channel contents are not erased.

- 1) Push the [VFO/M] switch to select MEMORY mode.
- 2) Rotate the TUNING CONTROL to select the desired memory channel.
- 3) Push and hold the [MW] switch until three beeps are emitted from the speaker.
 - The memory contents have been transferred into VFO.
 - The transceiver returns to VFO mode.

6 RELATED FUNCTIONS

6-3 SCAN FUNCTIONS

(1) PROGRAMMED SCAN

There are two scan functions: programmed scan and memory scan. The memory skip function can be used with memory scan.

The programmed scan function scans between two frequencies.

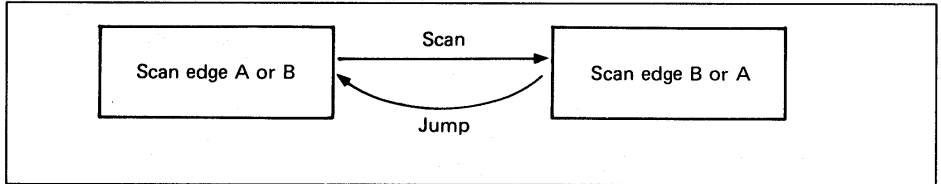

NOTE: Programmed scan does not function when:

- priority watch is activated. (p. 24)
- scan edge A and B are equal. (p. 21)

1) Select VFO mode.

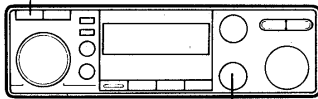

3) Rotate to threshold.

4) Push and hold while in VFO mode.

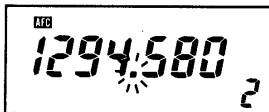
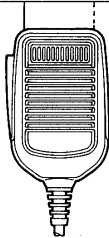

1) Select VFO mode. (p. 11)

2) Set scan edge frequencies using SET mode. (p. 21)

3) Rotate the [SQL/MONITOR] control to the squelch threshold point.

- The [RX] indicator goes out.

4) Push and hold the [UP] or [DN] switch on the microphone for about 0.5 sec. to start the scan, and then release the switch.

- [UP] : upwards scan.
- [DN] : downwards scan.
- The decimal point flashes.

5) When receiving a signal, scan stops.

- After 15 sec., scan resumes.
- 2 sec. after the signal disappears, scan starts again.

6) To cancel the scan, push the [UP] or [DN] switch on the microphone.

- The TUNING CONTROL and some other switches also cancel the scan.

USING SET MODE■ **SETTING SCAN
EDGES**

- 1) Select VFO mode. (p. 11)
- 2) Push the [SET] switch until "A" flashes in the right corner of the FUNCTION DISPLAY as shown at left.
- 3) Rotate the TUNING CONTROL to set the desired "A" scan edge frequency.
 - Use the [TS] switch together with the TUNING CONTROL to advance the frequency in a MHz step.
- 4) Push the [SET] switch once.
 - "b" flashes on the FUNCTION DISPLAY.
- 5) Rotate the TUNING CONTROL for the other "b" scan edge.
- 6) Push the [VFO/M] switch to set scan edges and return to VFO mode.

6 RELATED FUNCTIONS

(2) MEMORY SCAN

The memory scan function scans all memory channels in succession. To skip certain channels, use the memory channel skip function. (p. 23)

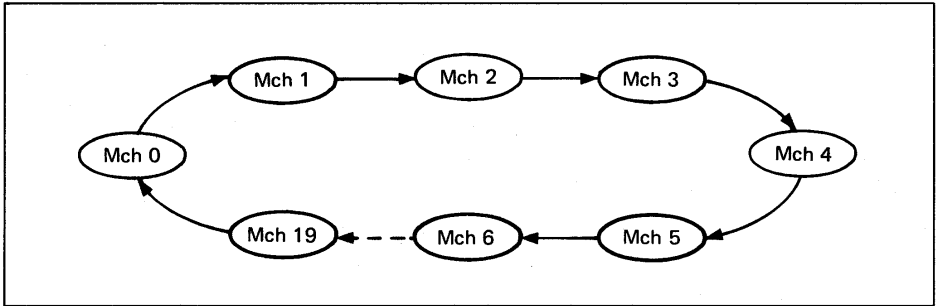

1) Select MEMORY mode.

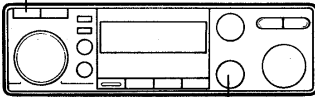

2) Rotate to threshold.

3) Push and hold while in MEMORY mode.

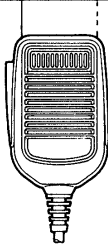

- 1) Select MEMORY mode with the [VFO/M] switch. (p. 18)
- 2) Rotate the [SQL/MONITOR] control to the squelch threshold point.
 - The [RX] indicator goes out.
- 3) Push and hold the [UP] or [DN] switch on the microphone for about 0.5 sec. to start the scan, and then release the switch.
 - [UP] : upwards scan.
 - [DN] : downwards scan.
 - Both "M" and the decimal point flash.
- 4) When receiving a signal, scan stops.
 - After 15 sec., scan resumes.
 - 2 sec. after the signal disappears, scan starts again.
- 5) To cancel the scan, push the [UP] or [DN] switch on the microphone.
 - The TUNING CONTROL and some other switches also cancel the scan.

(3) MEMORY SKIP FUNCTION

This function is used to skip memory channels you do not wish to scan during memory scan.

The memory skip function can also be used for priority watch (VFO ↔ memory channels). (p. 24)

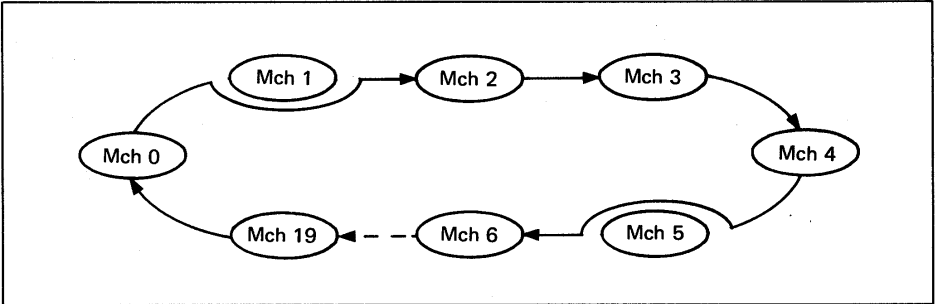

1) Select MEMORY mode.

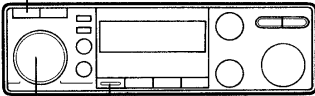

3) Push to program.

2) Select a channel.

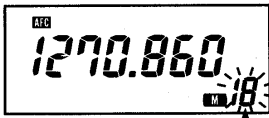

Programmed as a skip channel.

1) Select MEMORY mode with the [VFO/M] switch. (p. 18)

- "M" appears on the FUNCTION DISPLAY.

2) Select the memory channel to be skipped with the TUNING CONTROL.

3) Push the [SET] switch to program the selected memory channel to be skipped.

- Memory channel number flashes.
- To cancel the skip function, push the [SET] switch again.

4) Rotate the TUNING CONTROL to select other memory channels or push the [VFO/M] switch to return to VFO mode.

6 RELATED FUNCTIONS

6-4 PRIORITY WATCH

(1) VFO ↔ MEMORY OR CALL CHANNEL

Every 5 sec., priority watch monitors a frequency you programmed while you operate on the VFO frequency.

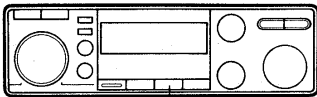
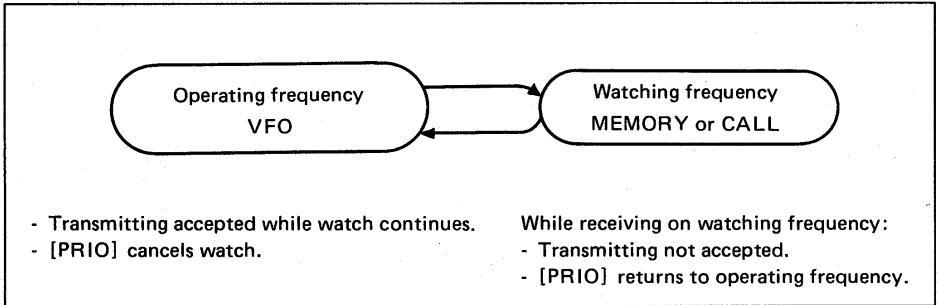

3) Push to start.

- 1) Set the desired operating frequency in VFO mode. (p. 11)
- 2) Select a memory channel or the call channel to be watched. (pgs. 18, 26)
- 3) Push the [PRIO] switch to start priority watch.
 - "PRIO" appears on the FUNCTION DISPLAY.
- 4) When a signal is received on the watching frequency (memory or call channel), priority watch stops for 15 sec.
 - "PRIO" flashes.
 - After 15 sec., priority watch resumes.
 - 2 sec. after the signal disappears, priority watch starts again.
- 5) To cancel priority watch, push the [PRIO] switch when the operating frequency is displayed.

(2) VFO ↔ MEMORY CHANNELS

Priority watch can also watch each memory channels in approx. 5 sec. consecutive intervals.

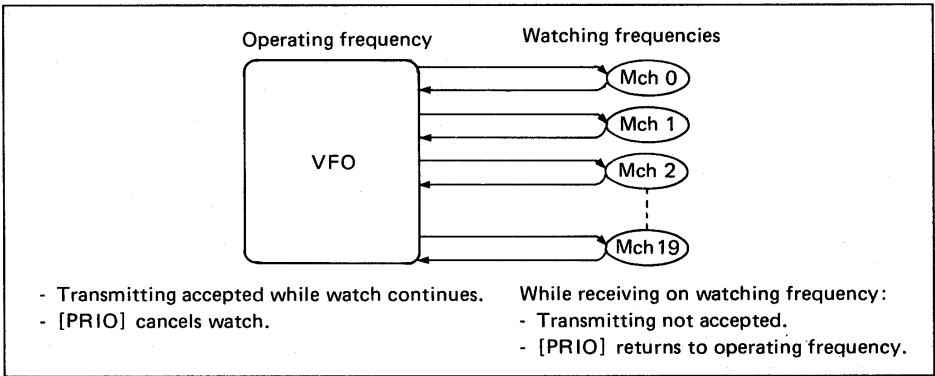

1) Set the desired operating frequency in VFO mode. (p. 11)

2) Push the [VFO/M] switch to select MEMORY mode.

- The memory skip function can be used. (p. 23)

3) Start memory scan.

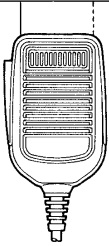

3) Push and hold the [UP] or [DN] switch on the microphone for about 0.5 sec. to start memory scan. (p. 22)

4) Push the [PRIO] switch to start priority watch.

- "PRIO" appears on the FUNCTION DISPLAY.
- Memory channels change every 5 sec.



4) Push to start priority watch.

5) When a signal is received on the watching frequency (memory channel), priority watch stops for 15 sec.

- "PRIO" flashes.
- After 15 sec., priority watch resumes.
- 2 sec. after the signal disappears, priority watch starts again.

6) To cancel priority watch, push the [PRIO] switch when the VFO frequency is displayed.

6 RELATED FUNCTIONS

6-5 CALL CHANNEL MODE

The transceiver has an independent CALL CHANNEL mode which provides easy selection of your most used frequency.

CALL CHANNEL mode can be selected from VFO and MEMORY modes.

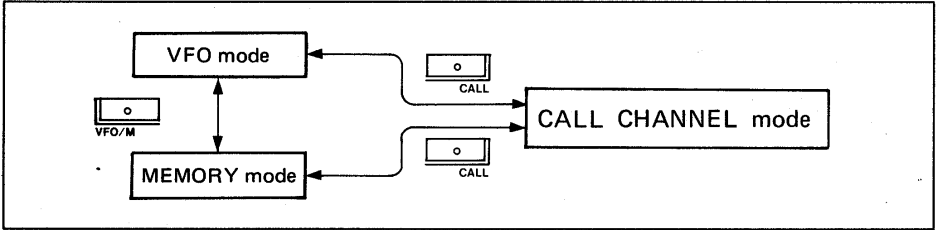

(1) CALL CHANNEL READING

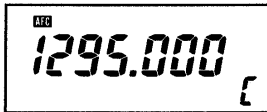
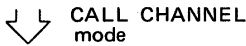
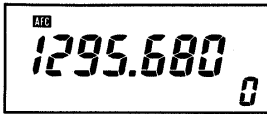

1) Push the [CALL] switch to select CALL CHANNEL mode.

- "C" appears in the place of the MEMORY CHANNEL READOUT.
- The TUNING CONTROL is deactivated.

2) Push the [CALL] switch again to return to the previous mode.

- The [VFO/M] switch also leaves CALL CHANNEL mode.

(2) CALL CHANNEL PROGRAMMING

In CALL CHANNEL mode

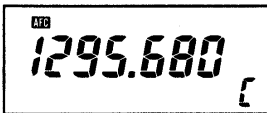

Push and hold.

1) Push the [VFO/M] switch to select VFO mode.

2) Select the frequency as a call channel.

- Repeater or other information can be programmed. (pgs. 14, 29)

3) Push the [CALL] switch to select CALL CHANNEL mode.

4) Push and hold the [MW] switch until three beep tones are emitted from the speaker.

- The selected frequency is programmed into the call channel.

6-6 DIMMER CONTROL

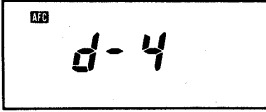

The display shows the brightest intensity.

The intensity of the FUNCTION DISPLAY back-light is adjustable as follows:

- 1) Select VFO mode. (p. 11)
- 2) Push the [SET] switch until "d-1", "d-2", "d-3" or "d-4" appears on the FUNCTION DISPLAY.
- 3) Rotate the TUNING CONTROL for the desired lighting intensity.
- 4) Push the [VFO/M] switch to set the intensity and to return to VFO mode.

6-7 BEEP ON/OFF

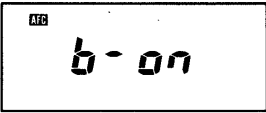

The display shows that beep is ON.

The speaker emits a beep tone each time a switch is pushed. Turn ON or OFF beep tones as follows:

- 1) Select VFO mode. (p. 11)
- 2) Push the [SET] switch until "b-on" or "b-off" appears on the FUNCTION DISPLAY.
- 3) Rotate the TUNING CONTROL to select beep ON and OFF.
- 4) Push the [VFO/M] switch to set the condition and to return to VFO mode.

6-8 LOCK FUNCTION

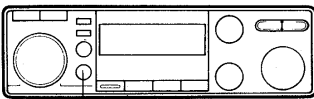

Push to lock.

This function deactivates the TUNING CONTROL and switches on the front panel.

- 1) Push the [LOCK] switch to lock switches and the TUNING CONTROL.
 - The [SQL/MONITOR], [PUSH-ON/VOL] controls and [PTT] switch are not locked.
- 2) Push the [LOCK] switch again to unlock.

7-1 UT-40 INSTALLATION

Install the optional UT-40 TONE SQUELCH UNIT for pocket beep and tone squelch functions.

CAUTION: Turn OFF power and disconnect the DC power cable before removing covers from the transceiver.

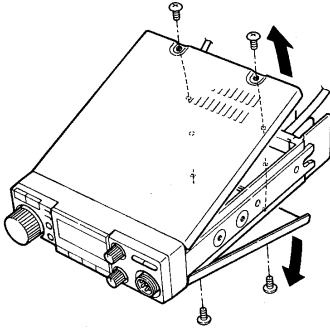

Fig. 1

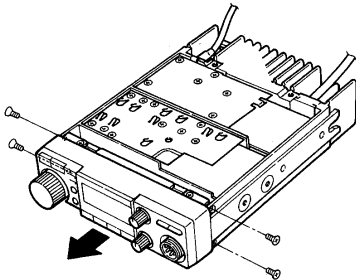

Fig. 2

- 1) Remove 4 screws from the top and bottom covers and remove the covers. (Fig. 1)
- 2) Remove 4 screws from the left and right sides of the front panel. (Fig. 2)
- 3) Remove the front panel. (Fig. 2)
- 4) Connect P5 plug (10 pins) from the IC-1201A/E PLL UNIT to the UT-40 connector. (Fig. 3)
- 5) Peel off white sheet from the back of the UT-40.
- 6) Install the UT-40 in the proper position. (Fig. 3)
- 7) Replace the front panel, covers and screws.

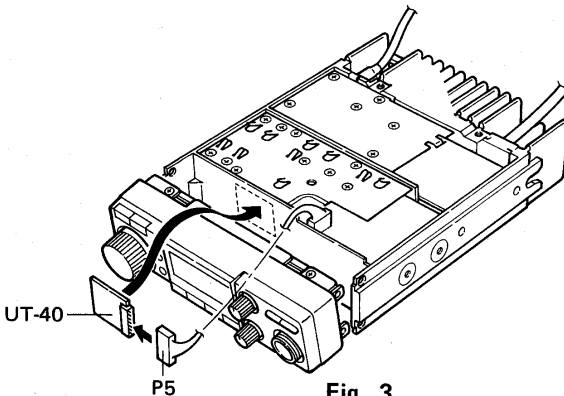
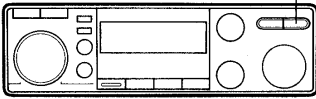

Fig. 3

7-2 POCKET BEEP FUNCTION

The pocket beep function alerts you using 30 sec. beep tones and "SQL" flashing when a signal with the same subaudible tone as pre-programmed is received. The optional UT-40 is necessary.

Push to select the pocket beep function.



NOTE: Some repeaters are equipped with filters that filter out subaudible tones. Using the pocket beep or tone squelch function when contacting other stations may not always be possible.



- 1) Set the desired subaudible tone frequency. (p. 15)
- 2) Push the [T/T.SQL] switch until "SQL" appears on the FUNCTION DISPLAY.
- 3) When a same subaudible tone as preprogrammed is received, beep tones are emitted from the speaker.
 - "SQL" flashes on the FUNCTION DISPLAY.
- 4) Push any switch on the front panel or the [PTT] switch on the microphone to stop beep tones.
 - The tone squelch function is automatically activated.

7-3 TONE SQUELCH FUNCTION

When a signal with the same subaudible tone as pre-programmed is received, the squelch opens. The optional UT-40 is necessary.

Push to select the tone squelch function.

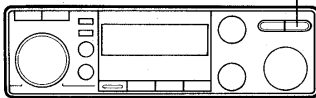

- 1) Set the desired subaudible tone frequency. (p. 15)
- 2) Push the [T/T.SQL] switch until "T SQL" appears on the FUNCTION DISPLAY.
- 3) When the same subaudible tone as pre-programmed is received, the squelch opens.
 - Push the [SQL/MONITOR] control to open the squelch, if desired.

8

MAINTENANCE

8-1 TROUBLESHOOTING

PROBLEM	POSSIBLE CAUSE	SOLUTION	REF.
1. Power does not come ON.	<ul style="list-style-type: none"> • Polarity of the power connection is reversed. • Blown fuse. 	<ul style="list-style-type: none"> • Reconnect the power cable observing the proper polarity. • Check the cause, then replace the fuse. 	<p>p. 7</p> <p>p. 32</p>
2. No sound comes from the speaker.	<ul style="list-style-type: none"> • The [SQL/MONITOR] control is turned too far clockwise. • The optional tone squelch is turned ON, if the UT-40 is installed. 	<ul style="list-style-type: none"> • Set the [SQL/MONITOR] control at the threshold point. • Turn OFF the tone squelch function. 	<p>p. 12</p> <p>p. 29</p>
3. No contact possible with another station.	<ul style="list-style-type: none"> • The transceiver is set to duplex. 	<ul style="list-style-type: none"> • Set to simplex. 	<p>p. 12</p>
4. Repeater cannot be accessed.	<ul style="list-style-type: none"> • Wrong offset frequency is programmed. • Wrong subaudible tone frequency is programmed. 	<ul style="list-style-type: none"> • Correct the offset frequency. • Correct the subaudible tone frequency. <p>Be sure the offset and subaudible tone frequencies are independently programmed on each memory channel.</p>	<p>p. 15</p> <p>p. 15</p>
5. Frequency cannot be set.	<ul style="list-style-type: none"> • The [LOCK] switch is turned ON. • CALL CHANNEL mode is selected. • RIT or VXO function is activated. 	<ul style="list-style-type: none"> • Turn OFF the [LOCK] switch. • Push the [CALL] switch to leave CALL CHANNEL mode. • Push the TUNING CONTROL. 	<p>p. 27</p> <p>p. 26</p> <p>p. 17</p>
6. Scan does not operate.	<ul style="list-style-type: none"> • Squelch is open. • Scan edge A equals B. • All memory channels are programmed as the skip channel. 	<ul style="list-style-type: none"> • Set the squelch threshold point. • Reset scan edges. • Cancel the memory skip function in the desired channel. 	<p>p. 12</p> <p>p. 21</p> <p>p. 23</p>
7. All programmed memories have been erased.	<ul style="list-style-type: none"> • Data error occurred in the CPU RAM because of the following problems: <ul style="list-style-type: none"> - The backup battery is empty. - The CPU has been damaged by static. 	<ul style="list-style-type: none"> • Replace the backup battery. <p>Reset the CPU.</p>	<p>p. 31</p> <p>p. 31</p>

8-2 CPU RESETTING

(1) AUTOMATIC RESETTING

The CPU automatically resets under the following conditions when power is ON:

- The backup battery is empty.
- Static or a magnetic field has caused a data error in the CPU RAM.

NOTE: Resetting the CPU erases all programmed information.

(2) MANUAL RESETTING

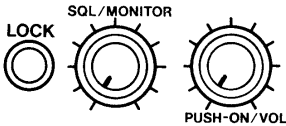

- 1) Turn OFF power.
- 2) Push and hold the [SQL/MONITOR] control and [LOCK] switch.
- 3) Turn ON power to reset the CPU.
 - "1295.000" appears.

(3) MINIMUM TUNING STEP SELECTION

To exchange 10 or 20 kHz tuning step increments for 12.5 or 25 kHz increments, (and vice-versa) reset the CPU.

• 10 kHz → 12.5 kHz

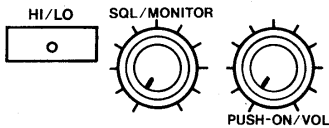

- 1) Turn OFF power.
- 2) Push and hold the [SQL/MONITOR] control and [HI/LO] switch.
- 3) Turn ON power.
 - Tuning step increment is now 25 kHz. Select a 12.5 kHz tuning step increment, if required. (p. 13)

• 12.5 kHz → 10 kHz

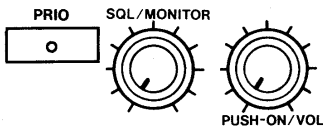

- 1) Turn OFF power.
- 2) Push and hold the [SQL/MONITOR] control and [PRIO] switch.
- 3) Turn ON power.
 - Tuning step increment is now 20 kHz. Select 10 kHz tuning step increment, if required. (p. 13)

8 MAINTENANCE

8-3 MISCELLANEOUS MAINTENANCE

■ FUSE REPLACEMENT

Locate the problem if possible before replacing a blown fuse.

- DC line fuses : 10 A

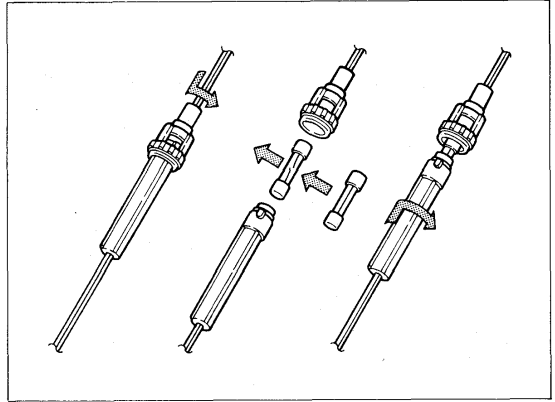

■ BACKUP BATTERY

The IC-1201A/E has a lithium backup battery for retaining memory information.

The usual life of the backup battery is approximately 5 years. When the battery is exhausted, the transceiver transmits and receives normally but the transceiver cannot retain memory information.

NOTE: Battery replacement should be done by an authorized Icom Dealer or Service Center.

■ CLEANING

When the transceiver becomes dusty or dirty, wipe it clean with a dry, soft cloth. Avoid the use of chemical agents such as benzine or alcohol as they may damage the surfaces of the transceiver.

■ ADJUSTMENT

Your IC-1201A/E has been thoroughly adjusted and checked at the factory before being shipped. Your transceiver warranty does not cover problems caused by unauthorized internal adjustments.

■ TOP VIEW (PA AND PLL UNITS)

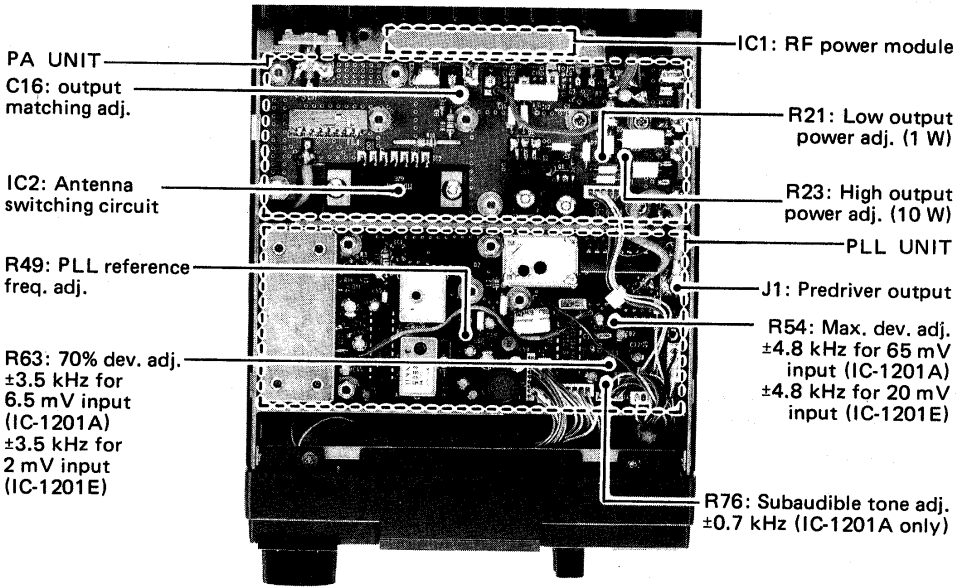

■ BOTTOM VIEW (RF AND RX UNITS)

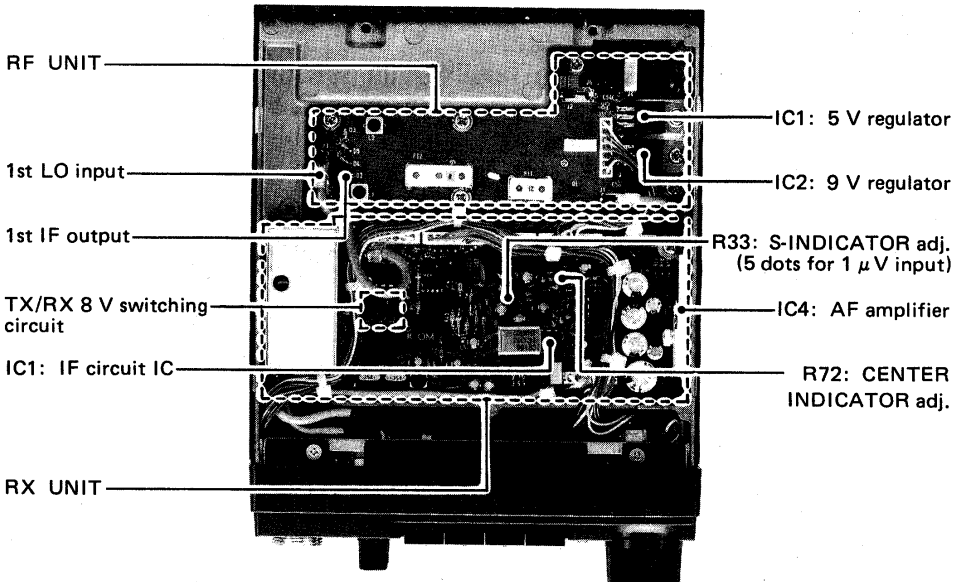

■ GENERAL

- Frequency coverage : 1240.0000 ~ 1300.0000 MHz
- Tuning step increment : IC-1201A 10 or 20 kHz
IC-1201E 12.5 or 25 kHz
- Memory channels : 20 and 1 call channel
- Mode : FM (F3)
- Antenna impedance : 50 Ω (unbalanced)
- Power supply requirement : 13.8 V DC \pm 15 % (negative ground)
- Current drain (at 13.8 V DC) :

Transmit	HIGH	6.0 A
	LOW	3.0 A
Receive	Squelched	800 mA
	Max. audio output	1.2 A

- Usable temperature range : $-10^{\circ}\text{C} \sim +60^{\circ}\text{C}$ ($+14^{\circ}\text{F} \sim +140^{\circ}\text{F}$)
- Frequency stability : ± 10 ppm ($-10^{\circ}\text{C} \sim +60^{\circ}\text{C}$; $+140^{\circ}\text{F} \sim +140^{\circ}\text{F}$)
- Dimensions : 140(W) x 40(H) x 200(D) mm
5.5 (W) x 1.6(H) x 7.9(D) in
(projections not included)
- Weight : 1.5 kg (3.2 lb)

■ TRANSMITTER

- Output power : HIGH 10 W
LOW 1 W
- Modulation system : Variable reactance frequency modulation
- Max. frequency deviation : ± 5 kHz
- Spurious emissions : Less than -50 dB (at HIGH output power)
Less than -40 dB (at LOW output power)
- Microphone impedance : 600 Ω

■ RECEIVER

- Receive system : Triple-conversion superheterodyne
- Intermediate frequencies : 1st 136.6 MHz
2nd 17.2 MHz
3rd 455 kHz
- Sensitivity : Less than 0.22 μV for 12 dB SINAD
- Spurious response rejection : Less than -60 dB (except 1/2 IF)
- Audio output power : More than 2.4 W at 10 % distortion with an 8 Ω load
- Audio output impedance : 4 ~ 8 Ω

All stated specifications are subject to change without notice or obligation.

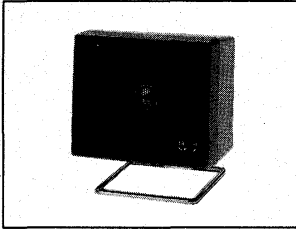

SP-7
EXTERNAL SPEAKER

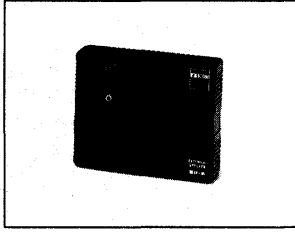

SP-8
EXTERNAL SPEAKER

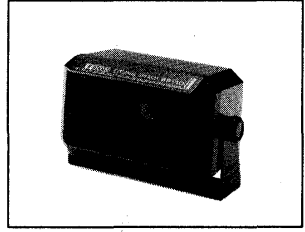

SP-10
EXTERNAL SPEAKER

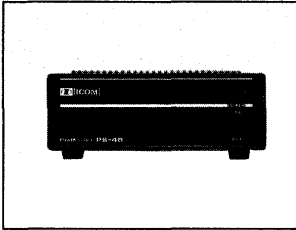

PS-45
AC POWER SUPPLY
(13.8 V DC 8 A)
An OPC-102 cable must be purchased separately.

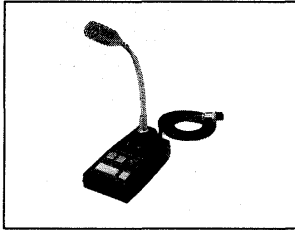

SM-8
DESK MICROPHONE

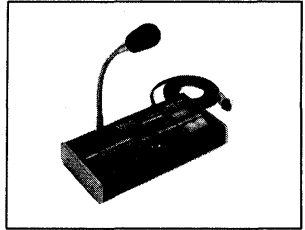

SM-10
COMPRESSOR/GRAPHIC
EQUALIZER DESK TOP
MICROPHONE

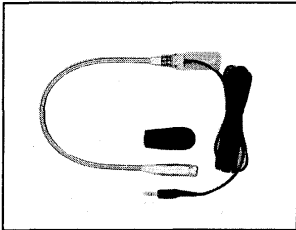

HS-15
FLEXIBLE MOBILE
MICROPHONE

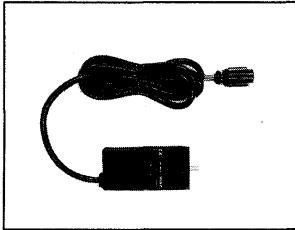

HS-15SB
SWITCHBOX
(for the HS-15)

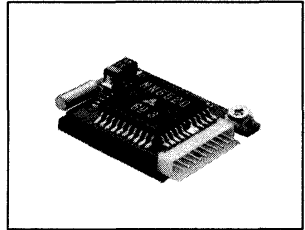

UT-40
TONE SQUELCH UNIT

AH-1200	1200 MHz MOBILE ANTENNA
AHB-1200	TRUNK MOUNT (for AH-1200)
WR-200	SWR & POWER METER (Optional WRC-1300 is necessary.)
WRC-1300	DIRECTIONAL COUPLER (1200 ~ 1300 MHz, max. 20 W)
HM-16	SPEAKER-MICROPHONE
HM-17	SPEAKER-MICROPHONE (Tone call switch included)

Count on us!

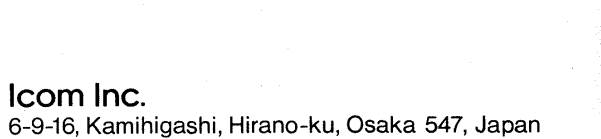
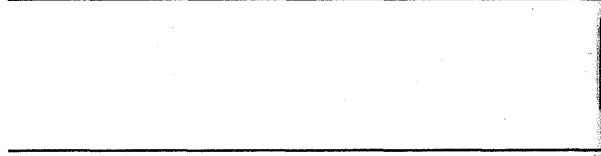
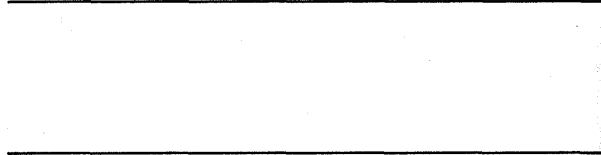
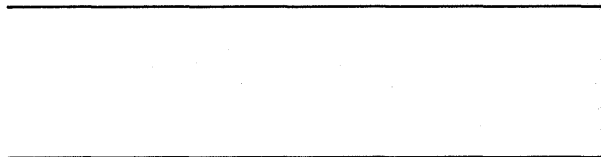
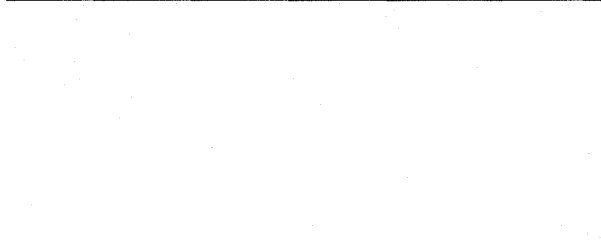
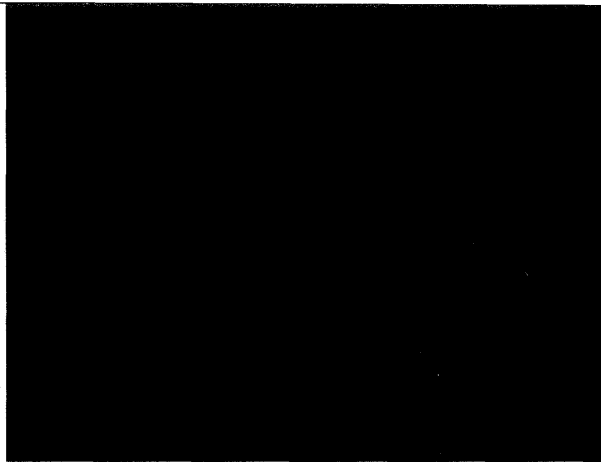

A-5040-1EX
Printed in Japan
Copyright © 1988 by Icom Inc.

Icom Inc.
6-9-16, Kamihigashi, Hirano-ku, Osaka 547, Japan

IC-1201A/E ERRATA

Please note the following 3 corrections in the IC-1201A/E instruction manual.

■ Page iii Second line from the bottom

WRONG

- HM-12 for IC-1201A (U.S.A. version)

RIGHT

- HM-14 for IC-1201A (U.S.A. version)

■ Page 5 2 - 4 MICROPHONE

Replace with the following information.

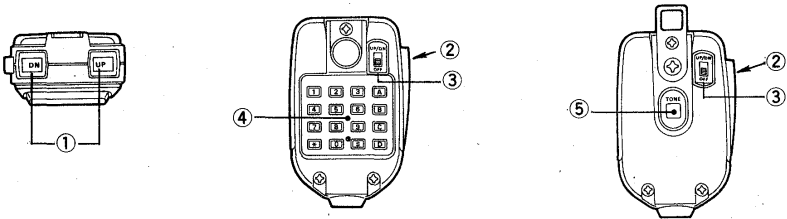

① UP/DOWN SWITCHES

Push either of these switches to change the operating frequency or memory channel.

Push and hold either of those switches to start scanning.

③ UP/DOWN ON/OFF SWITCH

Prevents accidental changes of the [UP] and [DN] switches.

④ DTMF KEYBOARD (HM-14 only)

Produces DTMF signals while transmitting.

② PTT SWITCH

Push to transmit.

⑤ TONE CALL SWITCH (HM-15 only)

Transmits a 1750 Hz tone signal.

■ Page 14 5 - 4 REPEATER OPERATION

Replace the tone information located at the bottom of the page with the following information.

• SUBAUDIBLE TONE

Push the [T/T.SQL] switch to turn the subaudible tone encoder ON and OFF.



"T" appears on the FUNCTION DISPLAY.
(U.S.A. version)

• DTMF TONE

Push and hold the [PTT] switch and then push the required number on the microphone back panel.



(U.S.A. version)

• 1750 Hz TONE CALL

Push and hold the [TONE] switch on the microphone back panel for approx. 1 ~ 3 sec. to transmit a 1750 Hz tone.



(Europe version)